

SENA

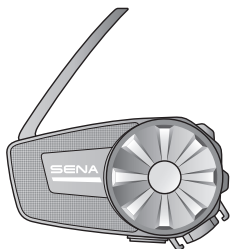

SPIDER ST1

모터사이클 메시 통신 시스템

HD SPEAKERS

빠른 시작 가이드

■ 다운로드 가능한 세나 소프트웨어

구글 플레이 스토어 또는 **앱스토어**에서
세나 모터사이클(SENA MOTORCYCLES) 앱을 다운로드 하십시오.



세나 모터사이클

www.senakorea.kr 에서 다음 항목들을 다운로드 하십시오.



펌웨어



세나 디바이스 매니저

- 펌웨어 업그레이드
- 기기 구성 설정



빠른 시작 가이드, 사용자 설명서

세나코리아 웹사이트 및 유튜브에서 최신 정보와 유용한 팁을
확인하십시오.

SENA
KOREA

웹 사 이 트 www.senakorea.kr
지 원 support@senakorea.kr
온 라 인 샵 www.senakorea.kr/shop
 YouTube youtube.com/SenaKorea

■ 제품 상세

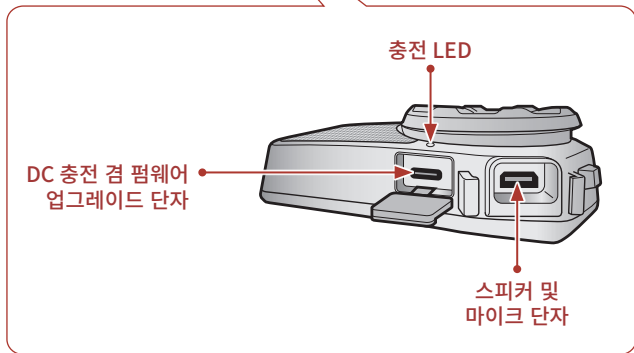
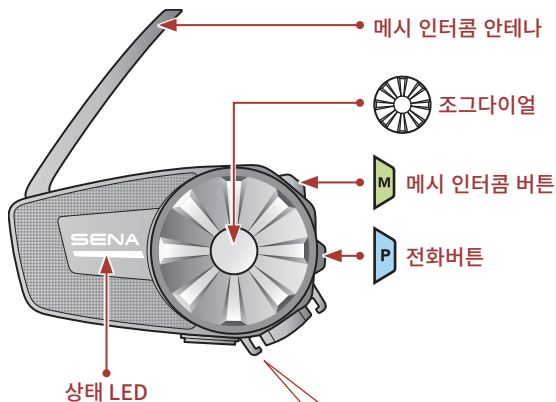

■ 설치

- 설치에 관한 자세한 내용은 사용자 설명서를 참조하십시오.

클램프유닛 사용

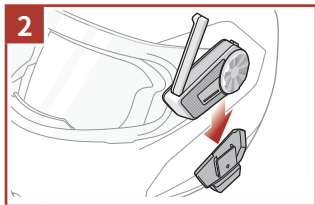
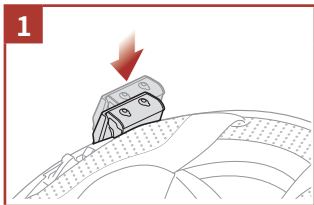

표면접착식 어댑터 사용

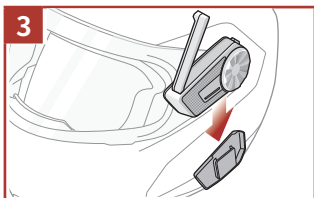
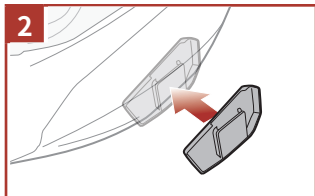
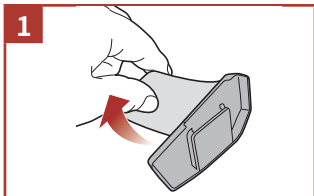

스피커 설치하기

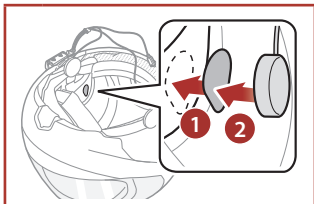

와이어 붐마이크 설치하기

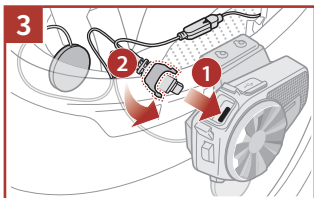
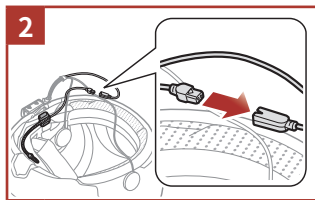
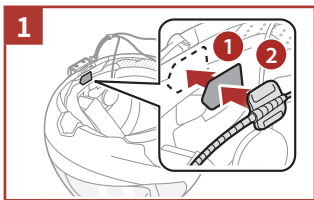

와이어 마이크 설치하기

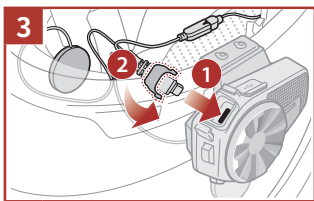
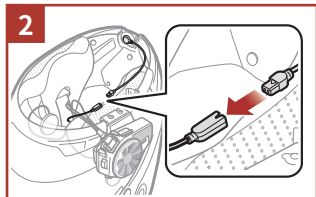
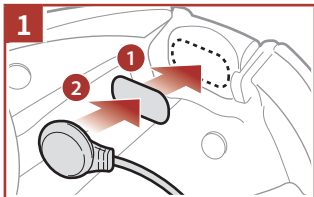

메시 인터콤 안테나

메시 인터콤 안테나를 바깥쪽으로 살짝 당기면 펴집니다.

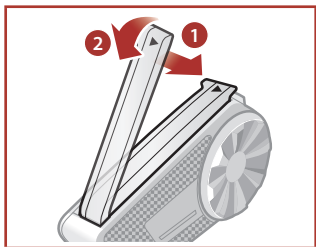

아이콘 일러두기

(TAP 1x) 살짝 누르기 버튼/조그다이얼을
지정된 횟수만큼 누르기

(HOLD 10s) 길게 누르기 버튼/조그다이얼을
지정된 시간 동안 누르고 있기



돌리기 조그다이얼을 시계 방향(오른쪽) 또는
반시계 방향(왼쪽)으로 돌리기



누른 상태에서 돌리기 조그다이얼을 시계 방향(오른쪽)
또는 반시계 방향(왼쪽)으로 눌러서 돌리기



"Hello /
안녕하세요"

음성 안내

기본 조작

전원 켜기

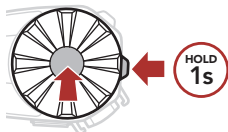

전원 끄기

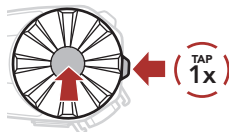

음량 키우기



음량 줄이기



■ 배터리 잔량 확인

전원 켜기



■ 폰 페어링

처음 헤드셋을 켤 때:



깜박임



"Phone Pairing /
휴대전화 페어링"

- ① 검색된 기기 목록에서 **SPIDER ST1**을 선택하십시오.



- 휴대전화 페어링에 관한 자세한 내용은 사용자 설명서를 참조하십시오.

전화 사용하기

전화 받기

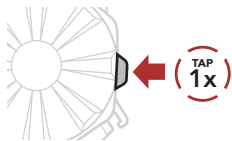

전화 끊기

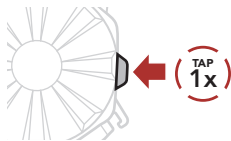

전화 거절하기



가상비서

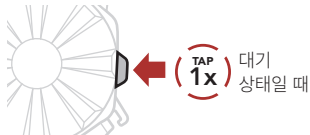

음악 재생

재생/일시정지



다음곡 이동



이전곡 이동



메시 인터콤™

오픈 메시™: 속해있는 채널 내에서 통신

그룹 메시™: 속해있는 비개방 그룹 내에서 통신

- **메시 인터콤**에 관한 자세한 내용은 사용자 설명서를 참조하십시오.

메시 인터콤 켜기



TAP
1x



깜박임 



"Mesh intercom on,
Open Mesh, Channel 1 /
메시 인터콤, 오픈 메시,
채널 1"

메시 인터콤 끄기



TAP
1x



"Mesh intercom off /
메시 인터콤 종료"

Note: 메시 인터콤을 처음에 켜면 **SPIDER ST1**은 **오픈 메시(기본: 채널 1)** 상태가 되고 자동으로 근처의 **SPIDER ST1**과 연결합니다.

■ 오픈 메시

오픈 메시에서 채널 설정 (기본: 채널 1)

① 채널 설정 진입



② 채널 이동

(1 → 2 → ... → 8 → 9 → 종료 → 1 → ...)

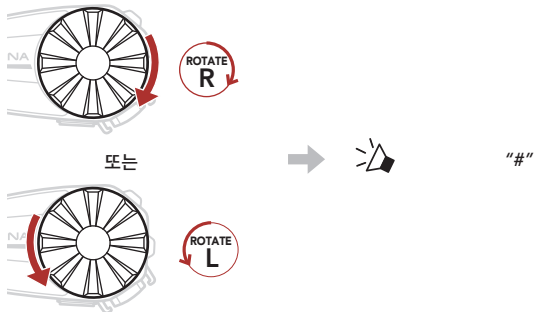

③ 채널 저장



Note: 세나 모터사이클 앱으로 채널을 변경할 수도 있습니다.

그룹 메시

그룹 메시는 비개방 그룹 인터콤 기능으로 각 헤드셋 간의 페어링 없이도 사용자가 그룹 인터콤 대화에 참여, 이탈, 재참여 할 수 있습니다.

1) 그룹 메시 생성하기

그룹 메시지를 생성하려면 **둘 또는 그 이상의 오픈 메시 사용자**들이 있어야 합니다.

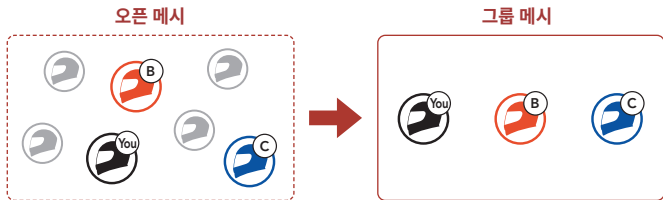

- ① 그룹 메시지를 생성하기 위해서는 **사용자들(나, B, C)**이 메시 그룹화에 진입합니다

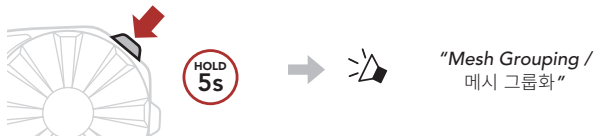

- ② 메시 그룹화가 완료되면 **사용자들(나, B, C)**은 오픈 메시에서 그룹 메시로 전환되었다는 음성 안내를 들을 수 있습니다.



2) 기존 그룹 메시에 참여하기

기존 그룹 메시지 참여자 중 한 명이 **오픈 메시지** 상태에 있는 **새로운 참여자들**을 기존 그룹 메시지에 참여시킬 수 있습니다.



- ① 기존 그룹 메시지 참여자 중 한명(사용자)과 기존 그룹 메시지에 참여하기 위해서 오픈 메시지 상태에 있는 새로운 참여자(D와 F)가 메시지 그룹화에 진입합니다.

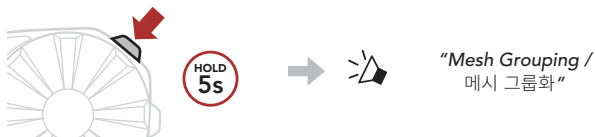

- ② 메시지 그룹화가 완료되면 새로운 참여자(D와 F)는 오픈 메시지에서 그룹 메시지로 전환되었다는 음성 안내를 들을 수 있습니다.



■ 마이크 활성화/비활성 (기본: 활성화)

사용자는 **메시 인터콧**으로 통신할 때 마이크를 켜거나 끌 수 있습니다.



■ 메시지 초기화

오픈 메시지 또는 **그룹 메시지** 상태에서 **메시** 초기화를 진행하면 자동으로 **오픈 메시지** (기본: 채널 1)로 되돌아 갑니다.



■ 설정메뉴

설정메뉴 진입하기



"Configuration Menu" /
설정메뉴

메뉴 옵션 이동

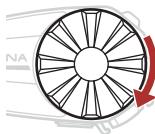

또는

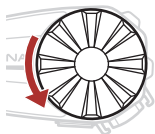

메뉴 옵션 실행

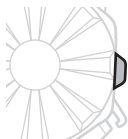

문제 해결

공장초기화



재설정(Fault Reset)

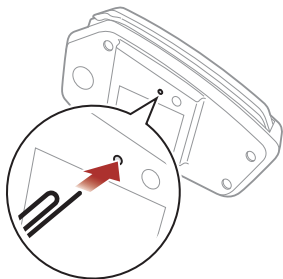

Note: 재설정은 헤드셋을 공장초기값으로 복원하지 않습니다.

■ 빠르게 알아보기

유형	조작	버튼 조작
 기본 조작	전원 켜기 / 전원 끄기	     
	음량 키우기 / 음량 줄이기	  또는 
 휴대전화	전화 받기	 
	전화 끊기	 
	수신 전화 거절	 
가상비서	 	
 음악	음악 재생/일시 정지	 
	다음곡 이동	 
	이전곡 이동	 

유형	조작	버튼 조작
 <p>메시 인터콤™</p>	메시 인터콤 켜기/끄기	 
	채널 설정	 
	메시 그룹화	 
	메시 초기화	 
	마이크 활성화/비활성	 