

# SPH10 빠른 시작하기

최신 한글 사용자 설명서를 [www.senablueooth.co.kr](http://www.senablueooth.co.kr) 에서 다운로드 하세요.

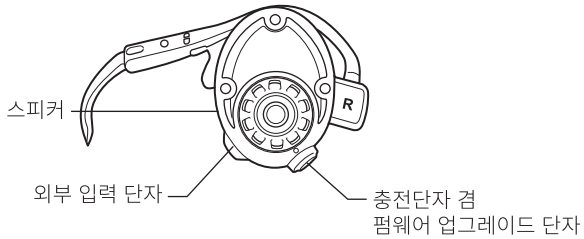
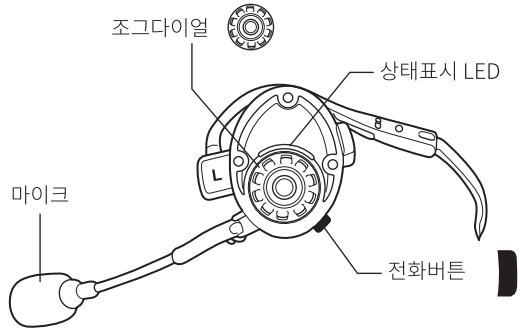

## 버튼 동작

← 누름 살짝누르기

← 1초 1초 동안 누르기

1

## 전원 켜기/끄기

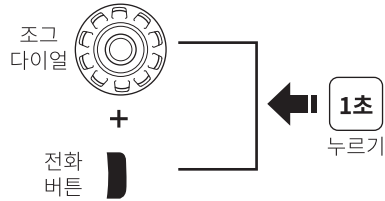

## 볼륨 조절

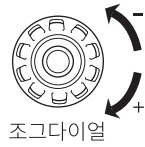

## 블루투스 페어링 휴대전화, MP3 플레이어, GPS 내비게이션

1. 헤드셋을 페어링 모드로 설정



2. Sena SPH10 선택

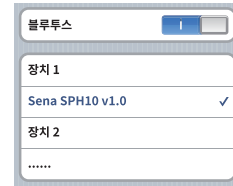

자동으로 페어링  
혹은 PIN 0 0 0 0 입력

2

## 휴대전화의 발신과 수신

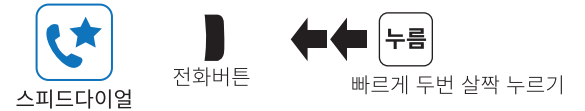

3

## 음악

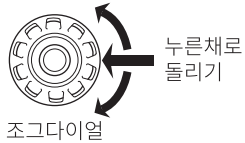
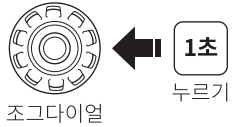

## 배터리 잔량확인



전원 켜기

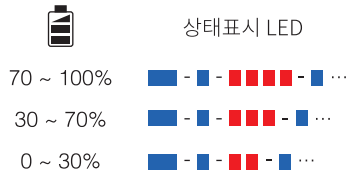

## 헤드셋 페어링 인터콤

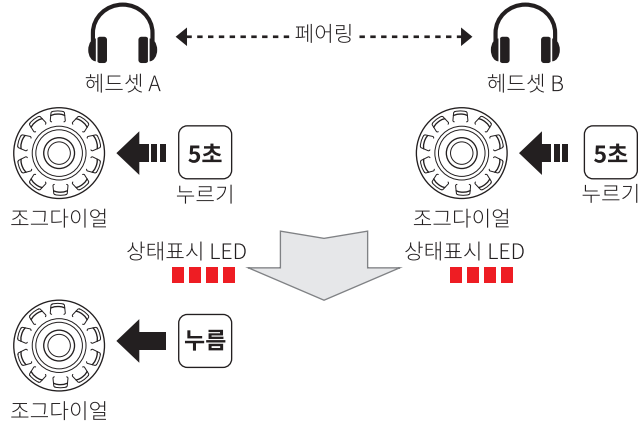

## 여러 대의 헤드셋 페어링 인터콤

마지막 인터콤 페어링 상대가 첫 번째 인터콤 대화상대가 됩니다.

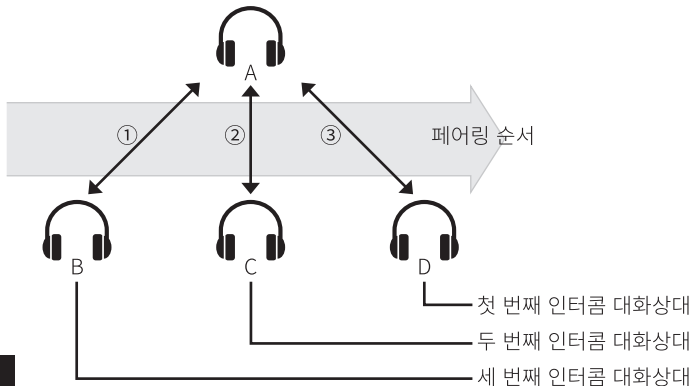

## 인터콤 대화 시작

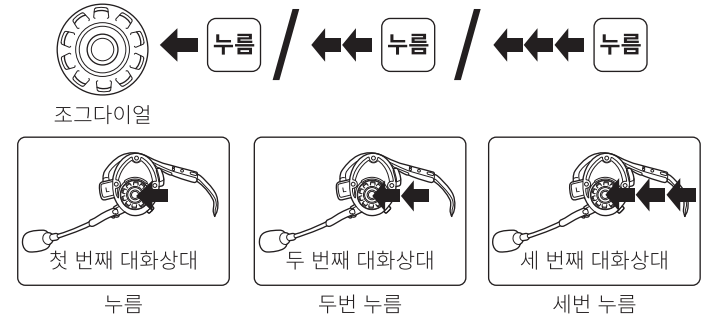

## 인터콤 대화 종료

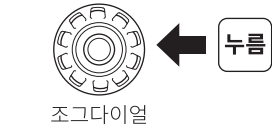

최신 한글 사용자 설명서와 펌웨어를 [senablueooth.co.kr](http://senablueooth.co.kr) 에서 다운로드 하세요.

**SENA**  
BLUETOOTH KOREA

세 나 블 루 투 스 코 리 아

www.senablueooth.co.kr  
www.facebook.com/senablueoothkr  
기술지원: support@senablueooth.co.kr

제품보증과 책임제한을 포함한 제품과 관련된 중요 정보는 세나블루투스코리아 웹사이트상의 사용자 설명서에 기술되어 있습니다. 본 제품을 사용하는 것은 고객이 해당 협약의 모든 조항에 동의하는 것을 의미합니다.

Printed in KOREA P/N: SENA\_SPH10\_QSG\_KR\_V1.0